

X maniac_ EN low B paraglider

MANUAL
EN REV.V01 - 2020



Copyright by:
GRAVITY airsports & more GmbH

Hütte 45
6345 Kössen / Austria
tel. +43 (0)720 519 402

mail. hello@gravityparagliders.eu
web. www.gravityparagliders.eu

photos copyright and photo & visual credits
GRAVITY airsports & more GmbH

1	PRODUCT_.....	7
1.1	GRAVITY X maniac _ performance guaranteed	7
1.2	Pilot Profile	9
1.3	Nature and environmentally friendly behaviour	9
1.4	Use.....	10
1.5	Signboard.....	10
2	POSSIBLE USE_.....	11
2.1	Motorised Paragliding	11
2.2	E-climbing assistance/ E-ascent aid.....	11
2.3	Towing winches.....	11
3	THE DEFAULT SETTINGS_	12
4	SECURITY PRECAUTIONS_	13
5	EQUIPMENT DESCRIPTION_.....	14
5.1	Short description	14
5.2	Technical data Xmaniac_	15
5.3	Innovations on our Product_	16
5.4	Colours and Design_.....	17
5.5	Riser belt	18
5.6	Speed/ acceleration system.....	19
5.7	TRANSPORTATION and STORAGE_.....	19
6	THE FLIGHT_.....	20
6.1	Flying experience	20
6.2	Take-off.....	20
6.3	Turning	21
6.4	Active flying	21
6.5	Landing	21
7	RAPID DECENT_	22
7.1	„Big Ears“	22
7.2	B-Stall.....	22
7.3	Extreme flight manoeuvres	23
7.4	Spiral Dive.....	23
7.5	Wingover.....	23
7.6	Front Collapse	24
7.7	Collapses	24

7.8	Deep stall.....	24
7.9	Full stall.....	24
7.10	Negative turn / spin.....	25
7.11	Emergency piloting/ control.....	25
8	REPAIRS_	25
9	MAINTENANCE and CLEANING_.....	25
9.1	Packing.....	26
9.2	Recycle.....	26
10	FLYING ACCESSORIES_.....	27
10.1	Xgear_ COMFORT IN ITS HIGHEST QUALITY	27
10.2	Xfusion _ guard, performance and quality - in a petite pack.....	28
11	PRESUMPTION OF RISK_.....	29
12	LIABILITY DISCLAIMER_	29
13	SAFETY ADVICE and LIABILITY_.....	29
14	LIABILITY EXEMPTION and WAIVER_	30
15	MAINTENANCE MANUAL_	30
15.1	Subject to inspection and inspection intervals	31
15.2	Who is authorized to check?	31
15.3	Rescue inspection equipment.....	31
15.4	Holes and cracks.....	31
15.5	Abrasion and expansions	32
15.6	Tear resistance control	32
15.7	Canopy porosity measurements	32
15.8	Connecting parts	33
15.9	Lines.....	33
15.10	Tensile strength values and tear resistance.....	33
15.11	Checking line lengths and fixings.....	34
15.12	Line length measurements:	34
15.13	Stitch/ Sewing control of trimming and settings.....	34
15.14	Miscellaneous.....	35
16	IMPORTANT -> carried out inspections	35

SERVUS

There are those very special and rare scenes and encounters in time, when we indulge in the present, feeling the now and simply pure joy. The GRAVITY team has devoted its efforts, work and vision entirely to and around the pleasures and enjoyment to the art of flying. Not only do we all live the spirit and mind-set of safety and freedom every day, we also want to share it with as many people and like-minded airheads as possible! GRAVITY develops innovative products for paragliding and offers a full-service range with the great desire to make our products accessible to as many enthusiasts and sportsmen out there.

WE PROCLAIM -> Secured and lasting enjoyment!

GRAVITY strives for the highest level of passive safety, with inspiring, performing and convincing products that make you truly happy. Our products deliver reliably, supporting and aiding the pilot even in more challenging conditions.

It's simple that the fun factor increases significantly by reducing risk. Designing and manufacturing products, applying high, latest technological standards, originality with long-lasting quality.

AMBITIOUS DESTINATION -> Exceeding what is already great!

"Innovation is a trusted, strong driver and successful progress the best vessel!" With this we are aiming to improve, grow and develop personally and our devices every day. Evolving and advancing on certain thoughts and ideas about the current state of a product, how to improve safety and protection, including sustainability with fresh, out of the box angles and approaches. We are proud of our work, savour uncompromising quality and love our sport. The products are crafted and tested with utmost care, in order to create and maintain long lasting quality.

THE HEART OF TRADE -> man-kind

Managing the team responsibly and with care, treating our surroundings and nature with respect comes just as natural to us as how we communicate with each individual customer and pilot. The GRAVITY team and family keeps an authentic and plain management style. Evident, direct structures enable active, empowered interactions and makes us dynamic and flexible. We wish you many countless, lasting, impressive explorations and moments with your GRAVITY product.

A handwritten signature in black ink, appearing to be 'Stefan Berger', written in a cursive, stylized script.

Stefan Berger
owner & sales



Xmaniac



MANUAL

A small warning icon consisting of a triangle with an exclamation mark inside.

PAY ATTENTION_

This operating manual is an important part of the aircraft. Please study and revise it well and in detail, due to the fact that there is a legal OBLIGATION to deal with the air sports device and its special features prior commissioning it. The manual is intended to make the use **of the GRAVITY Xmaniac** as safe and easy as possible.

1 PRODUCT_

1.1 GRAVITY X maniac _ performance guaranteed

Xmaniac is a light version XC wing lifting every pilot to the next level with maximum safety. Our goal during the developing phase was to get a direct, low-end B-glider with the highest and optimal feel-good-factor. Xmaniac was designed to remain tolerant when in extreme conditions, precise and delivering performance and speed straight to the point when handled, equipped with the latest technologies and a shark nose ensuring higher stability. This glider will greatly inspire and enthuse every distance hunter from beginner to experienced, who wants to go on explorations and adventures, gliding for long hours and distances. The smooth operating and appealing behaviour is now fortified with more performance and great reserves when it comes to safety - and also with a noticeable intensification in speed.

The lustrous wing glides smoothly in mid-air and stays unruffled even in turbulent air. The Xmaniac is easily centered through its precise and direct handling. You can already grasp the harmonious development and the well-balanced overall concept of the Xmaniac when launching the glider, experiencing an relaxed and easy-going take-off.



Illustration 01_ GRAVITY Xmaniac

Chief-Designer Ernst Strobl optimised the aspect ratio of the wing in multiple steps and layers. The vast span of this sweet-tempered, or let's even call it forgiving, wing-concept allowed high increase in performance. The Xmaniac 5 is equipped with a shark nose which gives more stability at higher speeds. The 3D shaping gives the cell opening area a dynamic tension and enhances - in combination with the Precision Profile Nose (PPN) - the shape accuracy in the nose-area. Elaborate planning and calculations of the pre-tensioning and a precise ballooning help the profile to the perfect inflow. The High Pressure Crossport Design optimizes the lateral aeration of the cross ports and creates a balanced internal pressure of the wing. The line setup is very straight-forward with only 3 main lines. The line levels are color-coded, which helps a lot when sorting them and also during the flight.



Illustration 02_ GRAVITY Xmaniac

When choosing the ideal and most suitable mix of materials, we put the focus on maximum durability and lasting performance. The top-materials Dokdo 30 and Dokdo 20 create an evenly light weight and high abrasion strength. Especially during the sometimes harsh conditions of schooling and training, this special material mix for long-term durability, optimizes the shape retention enduringly. An easy-going and manageable line-concept with few main lines guarantees easy handling and a good overview during ground handling.

1.2 Pilot Profile

The Xmaniac is a cross-country wing that is safe and secures that any beginner reaches a new level when it comes to flying and improvement. A real low-end B-wing that surprises with its strong and lasting performance. The Xmaniac is known for its excellent climbing properties, in addition the new concept enabled a significant increase in speed.



Illustration 03_ GRAVITY Xmaniac

1.3 Nature and environmentally friendly behaviour

We ask you to perform our sport in a manner, that impacts nature and environment with minimum intensity or as little as possible. Please do not walk off-track paths, don't leave any waste, don't make noise uselessly and respect the sensitive biological habitat in the mountains or any nature surroundings. Especially at take-off areas maximum care for nature is necessary.

1.4 Use

The X Maniac was built exclusively for single-seat use and is a light air sports device with an empty space of less than 120 kg in the paraglider division. The X Maniac has been type tested and classified according to LTF / EN - B. Sampling Inspection

The approval of the product was carried out and conducted according to current legal requirements and specifications:

- Test guideline: LTF 91/09 & EN 926 -1:2016, 926-2:2013
- Test Centre: Deutscher Hängegleiterverband e.V. im DAeC

1.5 Signboard

The essential and relevant product data is positioned on each product by default and in accordance to the admission office. In the case of the entire GRAVITY paraglider range these are visibly placed at the centre of the canopy.

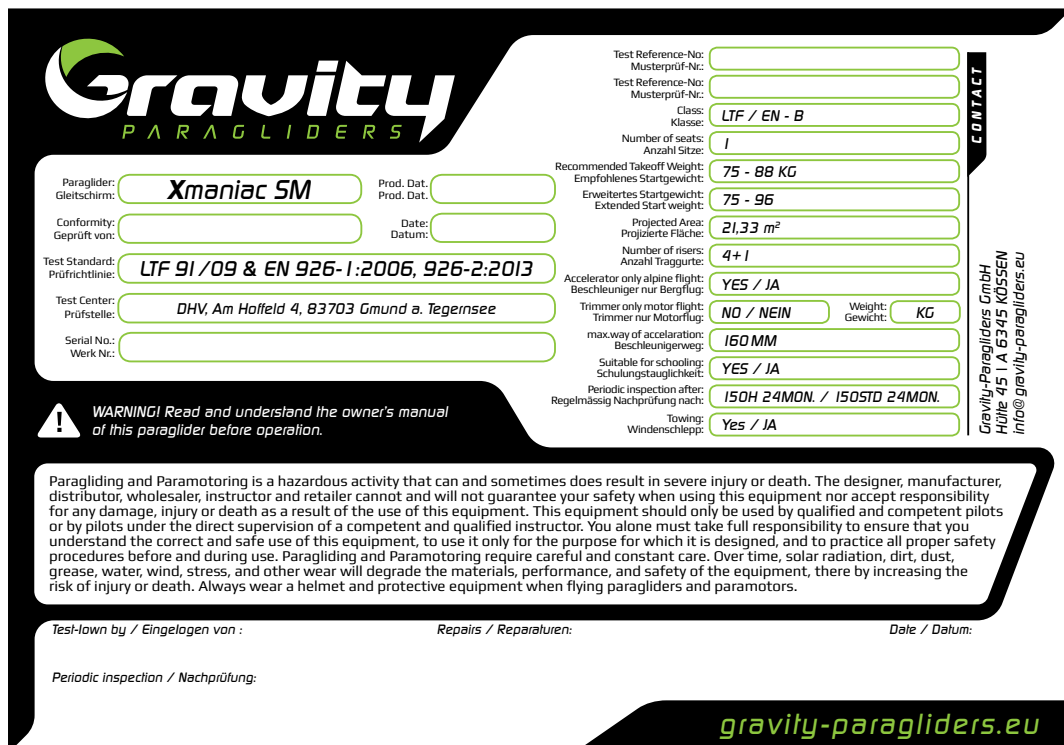



Paraglider: **Xmaniac SM** Prod. Dat.:

Conformity: Date:

Test Standard: **LTF 91/09 & EN 926-1:2006, 926-2:2013**

Test Center: **DHV, Am Hoffeld 4, 83703 Gmund a. Tegernsee**

Serial No.:

Test Reference-No.:

Musterprüf-Nr.:

Test Reference-No.:

Musterprüf-Nr.:

Class: **LTF / EN - B**

Number of seats: **1**

Recommended Takeoff Weight: **75 - 88 KG**

Erweitertes Startgewicht: **75 - 96**

Projected Area: **21,33 m²**

Number of risers: **4+1**

Accelerator only alpine flight: **YES / JA**

Trimmer only motor flight: **NO / NEIN** Weight: **KG**

max. way of acceleration: **160 MM**

Suitable for schooling: **YES / JA**

Periodic inspection after: **150H 24MON. / 150STD 24MON.**

Towing: **Yes / JA**

CONTACT

Gravity-Paragliders GmbH
Höfle 45 | A 6345 KÖSSEN
info@gravity-paragliders.eu

! WARNING! Read and understand the owner's manual of this paraglider before operation.

Paragliding and Paramotoring is a hazardous activity that can and sometimes does result in severe injury or death. The designer, manufacturer, distributor, wholesaler, instructor and retailer cannot and will not guarantee your safety when using this equipment nor accept responsibility for any damage, injury or death as a result of the use of this equipment. This equipment should only be used by qualified and competent pilots or by pilots under the direct supervision of a competent and qualified instructor. You alone must take full responsibility to ensure that you understand the correct and safe use of this equipment, to use it only for the purpose for which it is designed, and to practice all proper safety procedures before and during use. Paragliding and Paramotoring require careful and constant care. Over time, solar radiation, dirt, dust, grease, water, wind, stress, and other wear will degrade the materials, performance, and safety of the equipment, there by increasing the risk of injury or death. Always wear a helmet and protective equipment when flying paragliders and paramotors.

Test-torn by / Eingelogen von : Repairs / Reparaturen: Date / Datum:

Periodic inspection / Nachprüfung:

gravity-paragliders.eu

Illustration 04_ Signboard

2 POSSIBLE USE_

2.1 Motorised Paragliding

The Xmaniac is also well suited for motorized paragliding due to its excellent start and take-off attributes, its unproblematic handling and high trim speed. Please note that no acro-manoevres are allowed in motorised flight. Due to the higher wing and surface loading in the extended engine weight range, the according reactions are responding more dynamically. Opening the trimmer reduces the angle of attack and also causes a higher speed and thus more dynamic behaviour. It is recommended to keep the trimmers closed when flying through turbulent air. In order to keep the take-off distance and take-off speed low, the trimmers remain closed during take-off, especially when there is little wind. The extremely high area loading through the additional weight of the motor brings even the GRAVITY Xmaniac to its load limits. Pay attention to the extended engine weight range which changes / alters the take-off and landing speed considerably. Currently GRAVITY Xmaniac is not certified for motorised usage. Pay close attention to the fact that the allowed weight ranges must never be exceeded!

2.2 E-climbing assistance/ E-ascent aid

Due to its unproblematic handling and high trim speed, the GRAVITY Xmaniac is ideally suited for the e-ascent aid.

2.3 Towing winches

The GRAVITY Xmaniac offers excellent starting characteristics with its high trim speed, best conditions for towing winches. The following must be observed when towing winches/ aerotow:

- The GRAVITY Xmaniac must not be towed over 100 kp
- Unless towing on your "house winch", it is absolutely necessary to familiarize yourself with the local conditions in advance. Every "guest" in a foreign/ new flight area must be instructed by the local pilots.
- Never tow the GRAVITY Xmaniac with a load exceeding the approved weight limits
- All persons and facilities involved in winch operation must have the required qualifications or approvals for towing paragliders on the winch. This applies to the pilot, winch operator, towing device, towing pawl and all other devices for which a certificate of competence is required

3 THE DEFAULT SETTINGS_

The delivered brake line and default setting corresponds to the setting 0-leeway plus 5 cm. It is recommended to adjust the brake handle to your personal needs after the first flight. Remember that the brakes should not be set too short, otherwise the glider would fly continuously braked. These situations would be extremely dangerous for take-off, flight and landing!

The default setting is in extreme flight situations and when landing sufficient braking distance available. At the same time, it enables a comfortable arm position for the trim flight. Under no circumstances should the basic setting of the A, B and C lines be changed.



Please note that the relative braking distance changes with the height/ length of the harness. When fixing the setting, make sure that both sides are symmetrical and that a permanent knot is used. The double fisherman's knot/ spar or pile stitch has proven particularly effective in that since it weakens the lines the least with excellent slip resistance.

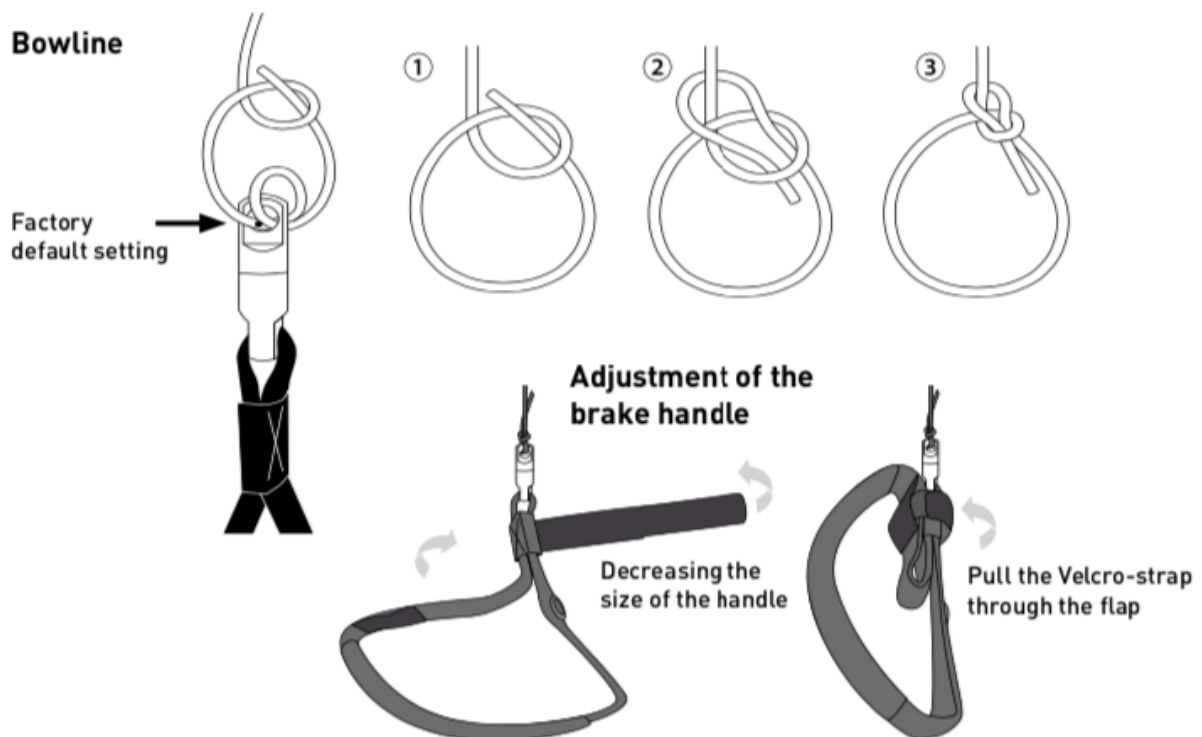

Illustration 05_ bowline/ double fisherman's knot

4 SECURITY PRECAUTIONS_

1. Before the first flight, the canopy, lines, all connections and sewing, the shackles, brake lines and brake line knots as well as any twisted lines must be checked by appropriately trained personnel and confirmed on the type plate
2. Make your first flight in a known flight area/ territory and in calm conditions
3. Test your GRAVITY Xmaniac only over water
4. During a "dynamic flight" the gravitation does not only affect you, but also on the glider. Do not underestimate this state and the forces!
5. Always fly your GRAVITY Xmaniac with at least one rescue device!
6. Compliance with the air traffic act and regulations are applicable in the respective country must be observed and revised carefully
7. Successful, certified completion of the appropriate training and license as well as the current existence of the appropriate level of knowledge / the current flight experience are prerequisites for using the GRAVITY Xmaniac
8. The use of suitable, tested and approved accessories (helmet, harness, rescue device) is a prerequisite for using the GRAVITY Xmaniac
9. Carry out a thorough material check of your equipment (top sail, bottom sail, ribs, especially the lines, carabiners, belt buckles, cloth, speed system, etc.) before every start
10. A flight with a crack or hole in the wing or line can be life-threatening
11. Always make sure that the aircraft is in a proper flying condition and that the required inspections have been carried out regularly
12. Be aware that as a pilot you must be physically and mentally able to carry out the flight unimpeded. You have to concentrate fully on flying in order to possibly avoid unpleasant flight conditions
13. Most accidents are due to pilot errors
14. Never fly near high-voltage lines, airports or highways, over people or during a thunderstorm! Otherwise you could endanger the life and physical integrity of third parties and / or your own and act grossly negligent at the same time!
15. The minimum distance must never be less than 50 m. At airports, this is a radius of 5 km
16. Find out about the prevailing weather conditions in the weather report and on site in advance
17. Only use the GRAVITY Xmaniac at wind speeds where you are able to control the glider 100%
18. Never use the screen during approaching thunderstorms or storms or when there is a high probability of thunderstorms or storms
19. Land immediately when thunderstorms or bad weathers approach!
20. Aerobic flying is generally prohibited and life-threatening. Unpredictable flight situations can occur that may get out of control. There is a risk of physical and thermal overload on the material and/ or the pilot



PAY ATTENTION_ Failure to disregard one or more safety precautions or violation can turn flight fun into a life-threatening event.

5 EQUIPMENT DESCRIPTION_

5.1 Short description

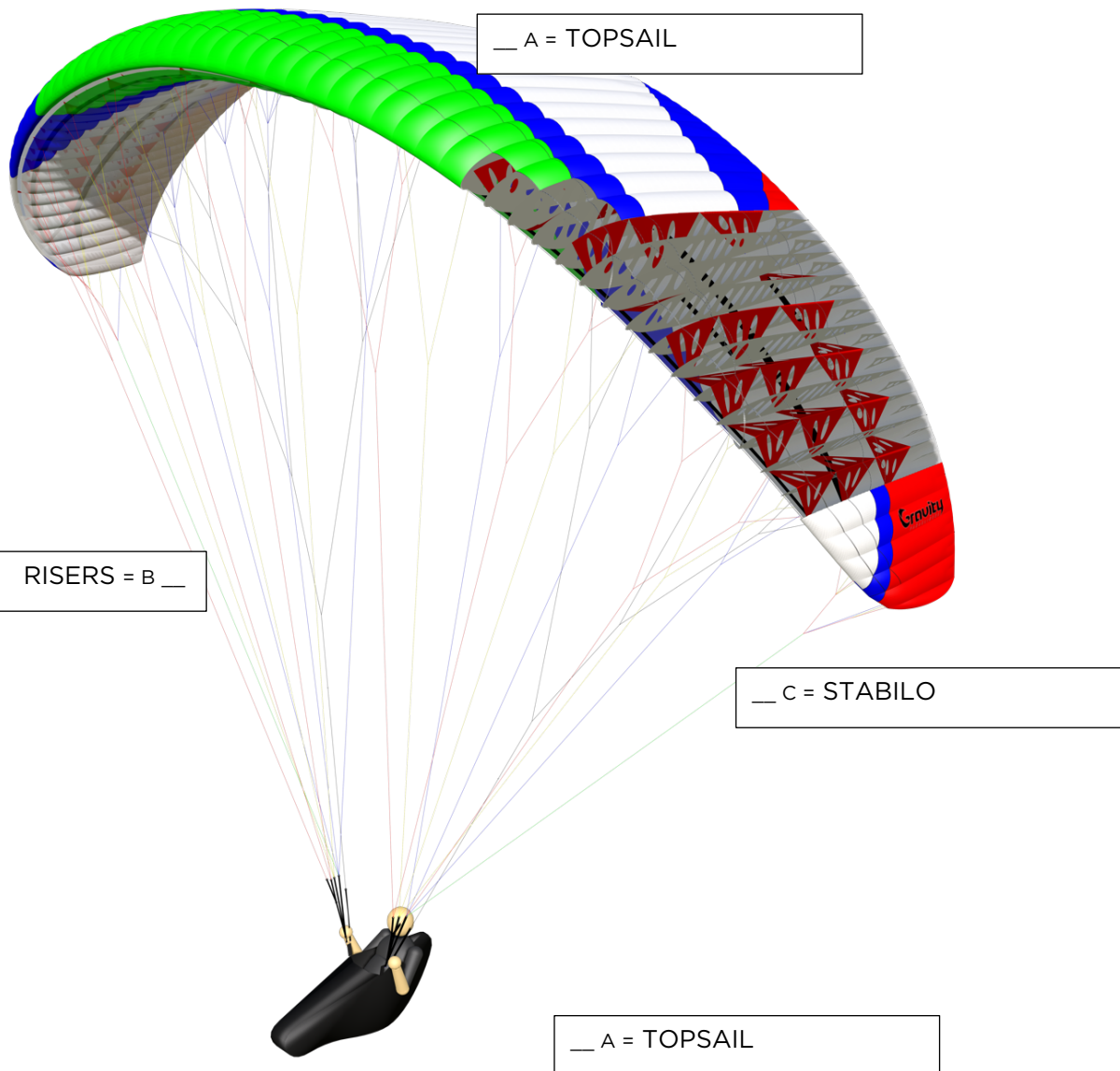

- A - Top Sail
- B - Risers
- C - Stabilo
- D - Riserbelt

Illustration 06_ device description

5.2 Technical data Xmaniac_

Specifications

Size	↕ XS	↕ S	↕ SM	↕ M	↕ L	↕
Recommended start weight	55 - 65 kg	65 - 75 kg	75 - 90 kg	90 - 105 kg	105 - 120 kg	
Extended start weight	55 - 70 kg	65 - 80 kg	75 - 95 kg	90 - 110 kg	105 - 128 kg	
Flat surface	21,4 sqm	23,2 sqm	25 sqm	27,3 sqm	29,8 sqm	
Projected surface	18,26 sqm	19,795 sqm	21,331 sqm	23,294 sqm	25,427 sqm	
Flat wingspan	10,615 m	11,089 m	11,511 m	12,029 m	12,567 m	
Projected wingspan	8,516 m	8,867 m	9,204 m	9,618 m	10,049 m	
Fiat AR	5,3	5,3	5,3	5,3	5,3	
Projected AR	3,971	3,971	3,971	3,971	3,971	
Chord: center / wingtip	2,454 m / 0,689 m	2,556 m / 0,721 m	2,653 m / 0,752 m	2,772 m / 0,783 m	2,896 m / 0,812 m	
V-Trim	37 - 38 km/ h	37 - 38 km/ h	37 - 38 km/ h	37 - 38 km/ h	37 - 38 km/ h	
V-Max	50 - 51 km/ h	50 - 51 km/ h	50 - 51 km/ h	50 - 51 km/ h	50 - 51 km/ h	
Bridle height	6,443 m	6,709 m	6,964 m	7,277 m	7,603 m	
Nr. of cells	50	50	50	50	50	
Glider weight	3,65 kg	3,84 kg	4,28 kg	4,56 kg	4,9 kg	
Bridle length	199,778 m	228,165 m	258,125 m	295,735 m	335,274 m	
Line diameter	0,7 / 1,0 / 1,2 / 1,4 / 1,6 / 1,9 mm	0,7 / 1,0 / 1,2 / 1,4 / 1,6 / 1,9 mm	0,7 / 1,0 / 1,2 / 1,4 / 1,6 / 1,9 mm	0,7 / 1,0 / 1,2 / 1,4 / 1,6 / 1,9 mm	0,7 / 1,0 / 1,2 / 1,4 / 1,6 / 1,9 mm	
Speed system/ trimmer	Yes / No	Yes / No	Yes / No	Yes / No	Yes / No	
Certification	EN-B / LTF-B	EN-B / LTF-B	EN-B / LTF-B	EN-B / LTF-B	EN-B / LTF-B	
Certified standards and procedures	LTF 91/09 & EN926-1:2006, 926-2:2013	LTF 91/09 & EN926-1:2006, 926-2:2013	LTF 91/09 & EN926-1:2006, 926-2:2013	LTF 91/09 & EN926-1:2006, 926-2:2013	LTF 91/09 & EN926-1:2006, 926-2:2013	
Folding lines used for certification	No	No	No	No	No	

Illustration 07_ technical table

5.3 Innovations on our Product_

The constant search for innovative technical and throughout high-performance solutions, always serves a higher safety standard in paragliding. Here is an overview of our most important innovations.



3D shape - providing specific tension control of the wing and therefore optimized ballooning and wrinkle free outline



high definition profile - plastic rods are working in the upper-side of profile and covering 45 to 80% on the cord



precision profile nose - plastic sticks on the profile nose for stronger profile parts



brake gathering system - this system allows the trailing edge on a calculated shorter situation for positive influences the brake characteristic

5.4 Colours and Design_

“Never change a winning horse!”

One of the unique selling points of the GRAVITY product range is that each glider product is only available in a single lead design and comes without colour variations or special designs. That way we can maintain supply capability within the agreed lead times and can guarantee the price stability. We are aiming at keeping basic calculations stable for sales and as well as within the production processes with forecasted quantities. We have made a big effort at creating each product of the glider product range holistically and to give each product unique features and moreover high recognition values.

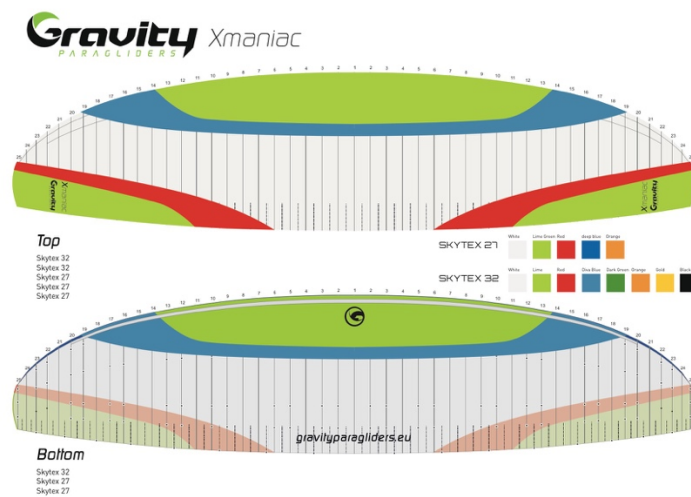

Illustration 08_ colour catalogue rendering

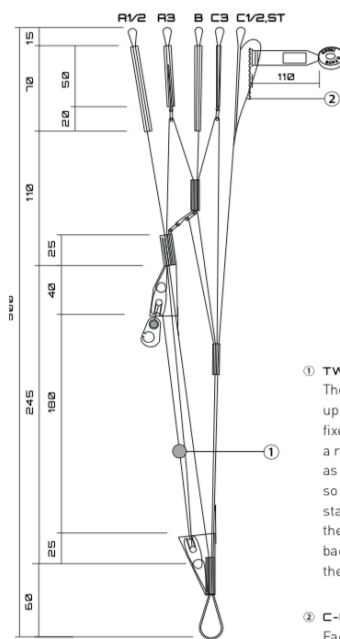

Illustration 09_ colour X maniac

5.5 Riser belt

The A- and B-risers have different colours to ensure positive identification at take-off and during a B-stall decent. Other adjustable, removable or variable mechanisms are non-existent. Number of risers: 3+1.

The risers of the GRAVITY Xmaniac are made out of 10mm dyneme tube webbing



- ① **TWO STAGE ACCELERATOR**
The accelerator travel and reduction is split up into 2 stages by a hollow ball its position is fixed by a knot on the rope the first stage has a reduction by factor 3 (the second stage by 2) as the ball reaches the pulley it is blocking it so that the reduction factor is in the second stage 2. the second stage has so an increased the sensitivity and gives so more wing feedback to the pilot. the pulley to pulley travel of the accelerator is 140 mm.
- ② **C-HANDLE**
Facilitates steering at the c-level and causes flat and efficient turning.



Illustration 10_ riserbelt

5.6 Speed/ acceleration system

The GRAVITY Xmaniac is equipped with a very effective foot extended acceleration speed system. It increases the speed when applied up to approx. 15 km/h depending on the wing size and pilot weight resp. surface loading. Through the level steered speed system, the profile form is maintained therefore the outstanding flight features are kept even in high speed. all extreme flight attitudes (e.g. collapses) happen at accelerated speed more dynamically.

The speed system needs to be adjusted before the first flight. Therefore, the connection lines of the foot extensor are being connected through the Brummel hooks with the speed system on the riser. To be able to undertake the right adjustment the harness should be hung up so you can sit in flying position. The attached risers are best held up by someone else. It should be adjusted in a way so that the pulleys are on top of each other and you have your legs stretched out. and you are also responsible to watch out that the speed system is adjusted symmetrically and not too short so the glider is not pre-accelerated in the flight.

The two-stage speed system also enables an exact fine adjusting at your harness (foot accelerator). By moving the knot that fixes the ball the accelerator distance and pressure can be individually adjusted.

1. If the knot is moved down towards the harness suspension, the second stage is reached sooner thereby the accelerator way is shortened.
2. If the knot is moved up towards the line shackles, the second stage is reached later and the accelerator way is getting longer.



NOTE_ Take care that the accelerator is not adjusted too short so the glider is not pre-accelerated before the flight

5.7 TRANSPORTATION and STORAGE_

When transporting the paraglider, make sure that it is not exposed to any kind of liquid. It must be packed dry. When storing the Xmaniac, it should be ensured that it is not exposed to UV rays. In addition, it must not be stored together with acids or the like or anywhere near them. Dry storage is extremely important.



PAY ATTENTION_ After a long storage period, the glider must be checked thoroughly.

6 THE FLIGHT_

6.1 Flying experience

These operating instructions only deal with the relevant points regarding flight technology that are important for the **GRAVITY Xmaniac**. It cannot and should not replace sound flight training in a recognized, authorised flight school! Without flight training and experience, flying with paragliders is extremely dangerous!

6.2 Take-off

After the paraglider has been unpacked and laid out in a semicircle, the following points must be followed and checked:

- 1.) the paraglider should be flattened out in a way that the lines in the middle of the paraglider are evenly under tension and slightly earlier than those at the wing ends when they are pulled up with the A-risers. This ensures an easy and directionally stable start
- 2.) When laying/ flattening out, please pay attention to the wind direction so that when pulling up against the wind both halves of the paraglider can rise symmetrically
- 3.) If the risers are not twisted, the brake lines run freely through the guides to the rear edge of the glider
- 4.) No lines are to run directly underneath the canopy cap. Make sure they are properly organized underneath the glider canopy. Otherwise it can have disastrous consequences
- 5.) The 5-point check should never be forgotten of course
The 5-point check should include the following:
 - a) buckled up/ strapped (helmet, harness and carabiners closed)
 - b) suspended (the risers are not twisted when hung in the carabiner, the accelerator is correctly hooked in, the carabiner is locked)
 - c) lines (A-lines above, all lines sorted, brake line runs freely to the brake roll(er))
 - d) canopy (cap is arched with an opened leading edge at the start)
 - e) wind and airspace (wind suitable for take-off, free airspace)

The centre of the screen of the GRAVITY Xmaniac is identified by the GRAVITY logo on the leading edge. It is sufficient to only take the A main risers (into your hands). Since the GRAVITY Xmaniac only shows very little tendency to shoot forward/ exceeding the pilot, it only needs to be slowed down a little in the starting phase. Any directional corrections with the brakes should only be undertaken when the canopy is already over the pilot, otherwise the glider can fall back due to excessive braking. The remaining risers should not be touched in the starting phase. The cap is filled with a steady, even pull and only a slight start impulse overall. Unlike conventional gliders, it is not necessary to fill the GRAVITY Xmaniac with strong wind-up movements or even a few quick steps. This also applies to little wind and even zero wind, Dosed winding is the easiest and safest way to start the GRAVITY Xmaniac. Once the pilot has made sure that the cap is fully open above him, the final decision to take off is made. After a few dynamic steps, the pilot takes off.

6.3 Turning

The GRAVITY Xmaniac has great manoeuvrability and reacts to control impulses directly and without delay. By shifting your weight, you can fly perfectly flat curves with minimal loss of height. A combined control technology consisting of the proportioned pull of the brake line on the inside of the curve and weight shifting is ideally suited for every turn. The brake line pull determines the curve radius. From approx. 75% one-sided brake line pull, the GRAVITY Xmaniac takes a significant side inclination and flies a fast and steep curve that can be extended to the spiral dive.



PAY ATTENTION_ If you pull a brake line too abruptly, the cap can turn negatively!

6.4 Active flying

In turbulent air, the GRAVITY Xmaniac should be flown lightly braked on both sides. Increasing the working angle increases the stability of the glider. When flying in strong thermals or in very rough conditions, make sure that the paraglider cap does not stay behind you. This can be prevented by loosening the brakes in order to take up some speed when flying into the upwind area. If the surface exceeds you when leaving flying into downwind areas, the paraglider must be braked accordingly.

When flying through downwind zones, accelerated flight makes sense. The design of the GRAVITY Xmaniac has a very high inherent stability. However, an active flight style in turbulent air (as described above) contributes significantly to increasing safety. Collapsing and deforming of the cap can be prevented by active flying.

6.5 Landing

Prepare yourself for landing already in sufficient height. Thanks to its excellent flare properties, the GRAVITY Xmaniac is easy to land if you brake at the right moment. From a straight final approach to the wind, you let the paraglider slide with normal speed and straighten up in time in the harness. Depending on the wind conditions, the brakes are resolved at a height of approx. 1 m and swiftly pulled until you reach the stalling point. Landings out of steep curves and quick changes of curve before landing are to be avoided due to the associated risk of swinging!



PAY ATTENTION_ During strong wind starts, ground handling and landing, the leading edge can hit the ground at very high speed. This is to be avoided, as otherwise profile tears, damage to the seams or the fabric can occur.

7 RAPID DESCENT_

Should a fast descent be necessary due to special weather conditions such as thunderstorms, a weather front, extreme winds or other dangers and hazardous situations occur, the following options are available:



PAY ATTENTION_ The manoeuvres described for quick/ fast descent put an extra amount of strain and pressure on your paraglider and should therefore only be used for training or used in emergency situations.

7.1 „Big Ears“

Both designated outer A2-risers (grab at or above the quick links) are being pulled down simultaneously for 15 - 20 cm to fold in the wing tips. The brake toggles are to be held in hand together with the pulled down a-lines. for additional stability and for an increased sink rate

the speed system should be actuated. The glider remains fully steerable by weight shifting and descents at an elevated sink rate (4-7 m/sec, depending on how many cells are folded in) straight forward. Once the a-risers are released, the folded wingtips re-inflate automatically, if not you may pump the brakes gently. due to the high wing load “big earing” is a very stable flight condition even in turbulent conditions. Please be aware that you reduce the trim speed during “big ears”, but this can be compensated by applying the speed bar. “Big ears” in combination with weight shifting in order to get the spiral dive, will achieve the highest sink rate. This decent method is often taught in SIV training. Be mindful that this exposes the glider to extreme loads, should one need to use this manoeuvre we recommend an equipment inspection afterwards.

7.2 *B-Stall*

Another very efficient method is the B-stall. The B-stall is generally known as the easiest decent method. But caution, if done wrong, it is anything but harmless! The B-stall allows a sink rate of 6 to over 9 m/sec. Check the airspace under and above you prior to initiating a B-stall. also pay attention to sufficient height. To initiate you hold the two B- risers above the quick links. With the brakes in hand at all times, pull down the B-risers progressively and symmetrically down to the shoulder to about chest level. hold this position. Your sail will stop, the wing will become partially empty and stabilize itself overhead. during this the wing will fall back a little, which must not tempt you to release the B-lines again. The glider would then shoot forward and oscillate vigorously. Only when the glider has stabilized overhead it is ok to exit the B-line stall. Therefore, bring the B-risers swiftly and symmetrically back into their original position. We recommend not to simply let the risers snap shut as this puts an enormous load on fabric, sewing and lines. In the paragraph titled “advanced handling” you can read what to do if unexpectedly caught in a stall.

7.3 Extreme flight manoeuvres

Even though the GRAVITY Xmaniac has a very high aerodynamic stability it is possible that the glider gets into an extreme flight situation due to pilot errors or turbulent air. The best method to stay calm and react correctly is to take part in a flight safety course. The pilot will learn to manage extreme flight situation under professional supervision. extreme flight manoeuvres may only be executed in calm air and in sufficient height under professional supervision (e.g. safety training). Once again we mention that a rescue system is required by the law.

The following extreme flight figures and flight manoeuvres can either be caused intentionally, through turbulences or through pilot errors. every pilot can get into these flight situations! all mentioned extreme flight figures and manoeuvres are dangerous if performed without the appropriate knowledge, enough altitude or necessary introduction. a wrong execution of these described figures and manoeuvres may have fatal consequences!

7.4 Spiral Dive

As with a normal turn, initiating the spiral dive is very easy with the GRAVITY Xmaniac. The spiral dive leads to very good sink rates (up to 15-20 m/sec). To safely use the spiral dive when necessary it should be practised in calm conditions. You move down vertically within the airmass. do not underestimate the g-forces that act upon the pilot when diving down in an efficient spiral.

The glider has a strong nose-dive when the bank increases during the spiral dive. The behaviour is very dynamic and should be piloted through lessening the brake-line-pull on the inside of the turn resp. accordingly with the outside brake and should only be practised under professional supervision.



PAY ATTENTION_ If initiated too quickly there is a risk that the canopy will turn/ spin negatively. In this case, release the brake again and start commence into the spiral manoeuvre again.

7.5 Wingover

The pilot has to perform right and left turns with increasing bank until the desired angle is reached. Collapsing wingtips are prevented by gently applying brake pressure in the up- and/ or down-swing of the wingover. Normally there is no danger of collapsing wing tips with the GRAVITY Xmaniac except for when there is a very high bank. With shifting the body weight while applying the brake it is possible to fly the highest possible wingovers.

7.6 Front Collapse

A negative angle of attack caused by turbulences of the simultaneous pull-down of the a-risers by the pilot, results in a frontal collapse of the leading edge. The GRAVITY Xmaniac comes out of a front- stall by itself very quickly. Smooth and symmetric applying of the brake positively influences the re-opening of the canopy. Evenly symmetrical pumping of the brakes can support reopening.

7.7 Collapses

Even with its high stability and great responsiveness in turbulences, strong turbulences can cause the canopy of the GRAVITY Xmaniac to collapse. Usually that situation is not dangerous and clears itself automatically without any further input. To support the recovery, firmly apply the brakes on the affected side and simultaneously steer opposite on the open side. When a large part of the canopy collapses the counter-steering is to be exercised in moderation in order not to completely interrupt the airflow to the positive side of the wing and spin the glider.

7.8 Deep stall

The GRAVITY Xmaniac is not sensitive to deep stalls. He ends a blind flight independently, initiated by pulling the brake lines or the rear risers too strongly, or by a B-Stall stalling too slowly, with the brakes or the rear risers released. If the glider is in a blind flight due to a special flight situation or flight configuration (e.g. too low take-off weight), the pilot ends it by symmetrically "pushing forward" the A-riser on both sides or kick the accelerator.



PAY ATTENTION Flight exercises, in which one deliberately causes the stall, should only be carried out at a sufficient safety level and height. Under no circumstances should the brakes be used one-sided during a deep stall, as this could cause the canopy to spin (negative curve). You should only release the brake once the Xmaniac is in a deep stall and the canopy nods forward.

7.9 Full stall

To initiate a full stall, both control lines are slowly brought to the stall point without winding. As soon as the stall point is reached, you keep your hands still and there. The glider tilts backwards. In this moment, the hands must never be put up. The canopy has to be stabilized and pre-filled before recovering the full stall. To do this, slightly release both brakes symmetrically. Both brakes are slowly and symmetrically released to fully reject. With correct symmetrical rejection, the cap surges forward quickly, as soon as the wing nods strongly forward, the glider must be braked briefly and firmly. An asymmetrical recovery must be avoided, there is a risk of falling/ diving into the glider.

7.10 Negative turn / spin

A negative turn/spin is initiated, when the pilot pulls the brake on one side fast and completely through to the point of stall while letting the other brake partly free. With a negative turn the glider turns relatively fast around its centre, while the inside flies backwards. In order to exit a negative spin, the applied brake is released, where stalled side of the wing can pick up speed or one exits through a full stall, by braking the flying side into a stall as well.



PAY ATTENTION_ The negative spin and the full stall are both unpredictable and dangerous flight manoeuvres and should never be deliberately flown except in safety training and carried out under professional instruction. There is a risk of a riser twist. The brake lines can get blocked during a twist.



PAY ATTENTION_ Using full stalls and negative curves/ spins as means to a quick descent is hazardous and dangerous, as incorrect recovery, regardless of the type of glider, can have disastrous consequences.

7.11 Emergency piloting/ control

If for some reason it is not possible to control the GRAVITY Xmaniac with the brake lines, it can also be controlled and landed very well with the back risers. Turns can be flown with a weight shift, but please pay attention that the glider does not lock in a spiral.

8 REPAIRS_

In general, repairs to paragliders may only be carried out by authorized service centres. Small damages such as cracks or small holes up to a size of 2 x 2 cm, which can be carried out without special equipment, may be carried out by the pilot him-/ herself. The supplied repair adhesive sail from the repair kit is to be used. Cracks or small holes are made from either side of the damaged area. Please note that the repair adhesive sail protrudes at least 2 cm above the damaged area on all sides. The adhesive sail can be cut to the appropriate shape. Rounding the corners prevents detachment and fraying.

9 MAINTENANCE and CLEANING_

Since only high-quality materials are used at GRAVITY, the GRAVITY Xmaniac will retain undiminished airworthiness for several years if it is properly cared for and maintained. How quickly your GRAVITY Xmaniac ages, ultimately depends on how often it is flown, where it is flown, how many UV-hours it accumulates and how carefully and regularly it is cared for. Below are some useful tips on care and maintenance:

- 1) Long-lasting UV-radiation and extreme acro-manoevres reduce the resistance of each paraglider cloth over time
- 2) Never expose your GRAVITY Xmaniac to unnecessary sunlight, but put it back in the glider bag after the flight
- 3) When choosing the take-off site, pay close attention to the surface on which the paraglider is laid out
- 4) Stacking the opening reinforcements properly increases the life-span of the paraglider
- 5) Don't drag your paraglider over the ground and pack it on grass
- 6) Please pay attention to the following:
 - a) the lines are checked regularly for damage
 - b) the lines are not nodded unnecessarily and you do not step on the lines when laying them out
 - c) check the strength and correct length of lines after overloading (tree landings, water landings, etc.) and have them replaced if necessary
 - d) when noticing changes in flight behaviour, all lines lengths must be checked.
 - e) the brake stem line on the brake handle must not be knotted unnecessarily, every knot weakens the line

The best way to clean the cap is to use warm, clean water and a soft sponge. Under no circumstances should chemicals be used for cleaning, as these damage the coating and the strength of the cloth. Always store your paraglider dry and protected from light, never near chemicals. After 24 months or 150 operating hours at the latest, the GRAVITY Xmaniac must be brought to the manufacturer or GRAVITY Competence Centre for inspection. On request, we would be happy to carry out the required inspection before, if you believe that it is necessary.

9.1 Packing

look for a clean - best case also soft - underlay to spread out your glider. free the cloth of soiling like leaves, grass or sand and sort the lines evenly. Use the riser-fix system at the rear end of the wing for the risers. make sure that the glider is try and clean before you pack it up. Now start to fold the glider from the middle out cell by cell. after that place both halves on top of each other and fold the glider to the end format. Shifted packing prevents constant abrasion of the middle of the paraglider.

9.2 Recycle

GRAVITY uses only safe materials and puts a lot of value into saving resources as well as using non-detrimental materials. Nevertheless, the materials used in a paraglider need proper disposal. Please return worn out gliders to GRAVITY airports & more GmbH or disassemble the glider into its parts and recycle them accordingly.

10 FLYING ACCESSORIES_

10.1 Xgear_ COMFORT IN ITS HIGHEST QUALITY

The GRAVITY Xmaniac can basically be flown with all approved harnesses without rigid cross bracing, which meet the corresponding minimum distances of the chest strap and suspension height through certification. The lower the harness's suspension point, the more direct the glider's reactions become when shifting weight. GRAVITY recommends the use of the very safe and comfortable all-round harness Xgear, which is perfectly matched to the Xmaniac. Xgear stands for relax to the power of 3 and this applies to the seating comfort as well as to the very high safety standard through the innovative foam protector. The light all-round harness is offering comfort in highest quality and processing – built for athletic adventurers.

The relative braking distance changes with the height of the harness. If you have any questions about using your harness with the GRAVITY Xmaniac, please contact your GRAVITY Competence Centre or GRAVITY directly.

We are happy to assist you!



Illustration 11_ Xgear allrounder harness

10.2 Xfusion _ guard, performance and quality - in a petite pack

GRAVITY presents a ground-breaking, innovative series of reserve parachutes in the latest format. The very light cross canopy X was designed and built, combining premium materials and the ultramodern technical enhancements, providing all constructional advantages of the square reserve parachute with a sensational weight of only 0.98 / 1.2 kg. The Xfusion not only impresses with its little pack-weight but also with precise and quick responsiveness when it comes to opening and sinking rates. Using delicate scaling and research, the cross-canopy shape as well as the air outlets making its flight behaviour practically free of pendulum movements. This series was produced to ensure safety, using highest quality standards in materials and production - designed to last and to keep you safe from beginner, ambitious, long distance to pleasure and fun-loving pilots.

Specifications

	✦ X100	✦ X115	✦ X130	✦ X150	✦ X220	✦
Weight	0.98 kg	1,20 kg	1,44 kg	1,68 kg	2,27 kg	
Surface	28,5 sqm	36,2 sqm	40,2 sqm	45,2 sqm	64,7 sqm	
Maximum payload (sink test)	100 kg	115 kg	130 kg	150 kg	220 kg	
Maximum payload (load test)	100 kg	115 kg	140 kg	160 kg	220 kg	
Sink Rate on maxload	5,6 m/ s	5,35 m/ s	5,1 m/ s	5,1 m/ s	5,3 m/ s	
Packing Volume	2380 cm3	3850 cm3	4180 cm3	4350 cm3	8700 cm3	
Panel	12	20	28	28	28	
Number of lines	24	24	28	28	28	
Total length	5,80 m	6,20 m	6,50 m	6,90 m	7,10 m	
Certification No.	LTF	EN / LTF	EN / LTF	EN / LTF	EN / EÜ_222.2018	

Errors, omissions reserved, subject to modification, changes and without notice. Reproduction in whole or part without written, confirmed permission of GRAVITY airsports & more GmbH is strictly prohibited and results in legal action.



USPs

- high safety aspect without horizontal drift
- extremely fast opening time
- unmatched pendulum stability with low sink rates
- very simple packing method with a small packing size
- high-quality material mix with water-repellent material
- cap construction with optimized air outlets
- minimal weight without reducing the geometry
- 220 kg lightest EN certified cross cap on the market

Illustration 12_ Xfusion product range

11 PRESUMPTION OF RISK_

The use of the GRAVITY Xmaniac poses certain dangers of physical injury or death to the user of this product or third parties. By using the Xmaniac you agree to accept all known and unknown, probable and unlikely risks of any kind of injury. The dangers associated with practicing this sport can be reduced by internalising the warning and safety requirements and content stated in the manual and the care required in individual cases, as well as common sense. The risks inherent in this sport can be largely reduced if you follow both the maintenance guidelines listed in these instructions for use and common sense.

12 LIABILITY DISCLAIMER_

By concluding the purchase contract for a GRAVITY Xmaniac, you declare your consent to the following points within the legal requirements: THE DISCLAIMER OF ALL AND EVERYTHING CLAIMS arising from the use of the GRAVITY Xmaniac and either its components now or in the future against GRAVITY airsports & more GmbH and all other contractual partners could grow up.

The legal release of GRAVITY airsports & more GmbH and all other contractual partners from any claims regarding loss, damage, injury or expenditure that you, your closest relatives and relatives or any other user of your GRAVITY Xmaniac can suffer from the use of the GRAVITY Xmaniac result, including the liability resulting from law or contract on the part of GRAVITY airsports & more GmbH and all other contractual partners in the manufacture and processing of the GRAVITY Xmaniac and all of its components.

With the occurrence of death or occupational disability, all of the provisions of law listed here come into force and also bind the heirs, closest relatives and next of kin, estate and asset managers, legal successors and legal representatives. GRAVITY airsports & more GmbH and all other contractual partners have given no other oral or written representations and expressly deny that this has been done, with the exception of what is stated here in and in the GRAVITY Xmaniac manual.

13 SAFETY ADVICE and LIABILITY_

At the time of delivery, this paraglider complies with the approval regulations of the EAPR (see Appendix). Any unauthorized change will invalidate the operating license! Each pilot bears responsibility for his own safety and must also ensure that the aircraft with which he / she flies is checked for airworthiness before each take-off.

Further we assume that the pilot is in possession of the required valid qualification and that the applicable legal provisions are complied with. Use the device at your own risk! Manufacturers and dealers assume no liability for accidents of any kind and their consequential damage. Follow the safety precautions to fly safely.

14 LIABILITY EXEMPTION and WAIVER_

You hereby declare that - before using the GRAVITY Xmaniac - you have read and understood the entire manual of the GRAVITY Xmaniac, including all instructions and warnings contained in this manual. In addition, you declare that you ensure that - before you allow someone else to use your GRAVITY Xmaniac - that any other users (who will take over the product from you permanently or for a limited period of time) have read as well as understood the entire user manual of the GRAVITY Xmaniac including all instructions and the warnings contained in this manual.

GRAVITY airsports & more GmbH accepts no responsibility, liability and / or guarantee for checks, inspections and repairs not carried out by it.

A handwritten signature in black ink, appearing to be 'Stefan Berger', written in a cursive style.

Stefan Berger
owner & sales

15 MAINTENANCE MANUAL_

English Release.1.0; January 2020

Copyright © 2020 by GRAVITY airsports & more GmbH, all rights reserved. No part of this publication may be reproduced or processed in any form without the written permission of GRAVITY airsports & more GmbH.

All technical information in this manual has been carefully checked by GRAVITY airsports & more GmbH. However, we would like to point out that no liability is accepted for any

incorrectly specified technical information. This applies to legal responsibility and liability for consequences that are based on incorrect information. We reserve the right to make ongoing changes to this manual insofar as they serve technical progress.

15.1 Subject to inspection and inspection intervals

Regular inspection according to the aircraft inspection regulations for certified paragliders. For end consumer devices after 24 months, for school devices after 12 months.

The inspection must be carried out according to the intervals specified above or at the latest after 150 flight hours. Ground handling should be included in the number of flight hours.



PAY ATTENTION_ in the event of abnormal flight behaviour, the manufacturer should be informed immediately and the glider sent in for checking if necessary.

15.2 Who is authorized to check?

In addition to the manufacturer or the person/ test centre commissioned by him, only the owner of the paraglider may personally carry out the two-year test, given he meets the requirements.

15.3 Rescue inspection equipment

Before the rescue system is packed, it must be checked by the packer. If the parachute has been opened for rescue, it must be checked.

If a rescue parachute is to be repacked, a trigger check must be carried out. It must be determined whether the release force is between a minimum of 3 and a maximum of 6 kg. Checking from the top and bottom sail, seams, all lines to the rescue system.

15.4 Holes and cracks

The upper and lower sails for paragliders and rescue systems must be checked panel for panel/ length of material from the leading edge to the sail's trailing edge. Should abnormalities reveal themselves while testing, the glider needs to be presented to the manufacturer for professional testing.

- 1.) Check for holes, small or large cracks, strains and chafe marks
- 2.) Defects on the coating, other abnormalities on the cap such as old repairs
- 3.) For rescue equipment, a light table must be used to check holes, chafing points and expansions

15.5 Abrasion and expansions

In the case of large and critical chafing, straining and stretching, the affected sailing tracks must be replaced by the manufacturer.

The determined values/ changes are to be noted in the inspection report!
Checking the ribs:

- 1) Visual inspection of the chambers (from the entry to the rear edge) to see whether the inner seams, cell partition walls and stiffeners are in good condition, i.e. without cracks, stretching, straining, chafing, damage to the coating
- 2) If the ribs are torn, the sewing/ stitching is defective, loose or missing, the glider must be sent to the manufacturer or an authorised dealership or competence centre
- 3) The specified values / changes are to be noted in the inspection report!

15.6 Tear resistance control

To be carried out with the bed meter at the following points (B.M.A.A. approved patent number GB2270768 Clive Betts Sails). The test sequence can be found in the operating instructions for the bettsometer.

- 1) Punch a needle-thick hole in the upper and lower sails of the A-line linkage and check the tear resistance
- 2) The limit value of the measurement is set to 500 g, and a crack length of less than 5 mm

The specified values / changes are to be noted in the inspection report!

15.7 Canopy porosity measurements

At all subsequent measuring points, the air permeability should be higher than at least 20 seconds (after Kretschmer). For smaller air permeability values, the paraglider must be sent to the manufacturer. Measuring points: The porosity measurements according to the Kretschmer measuring method (please observe the operating instructions) should be carried out at the following points on the cap. Perform tests on the lower and upper sails:

- 1) middle cell about 20 - 30cm behind the leading edge
- 2) 3rd cell from the middle left/ right approx. 20 - 30 cm behind the leading edge
- 3) 10th cell from the middle left/ right about 20 - 30 cm behind the leading edge

The specified values/ changes are to be noted in the inspection report!

15.8 Connecting parts

Checking the risers and und quick link openings:

- 1) are there chafe marks, kinks, cracks, strong signs of wear?
- 2) is all stitching tight?
- 3) is the accelerator movement free and intact?
- 4) are the brake loops still tight and firmly sewed?
- 5) are the line locks corrosion-free, is the thread free to move?
- 6) are the quick link openings/ line locks corrosion-free, is the thread tube clear and intact? Measurement under a load of 5 kg. The determined values are to be compared to the specifications from the DHV certificate form as a declaration of conformity.

Permitted deviations can be found in the manufacturer's instructions. If the shoulder strap or parts of it are defective, spare parts must be ordered from the manufacturer and the defective parts exchanged for an original spare part.

The specified values/ changes are to be noted in the inspection report!

15.9 Lines

Checking the line tear strength: Line selection: A medium A, B and C main line and, if available, a medium A and B cascade line are selected and checked for their tear strength with a tensile strength tester.

Pull speed of the pull cylinder: $v = 30 \text{ cm/ min}$

15.10 Tensile strength values and tear resistance

The specified values / changes are to be noted in the inspection report!



PAY ATTENTION_ A fixed value is assigned to each size (line diameter). If the lines cannot withstand the specified tensile load or tear resistance, all other lines must also be replaced. If the tested lines meet these test criteria, only the others will be replaced by new ones. All replaced lines must be marked near the shackle (seam) with a black pen and noted in the test report with the date of the exchange and amount of flight hours from the device. At the next check, an original line nearest to the replaced one is used for the line strength test. A minimal sewing length is assigned to the different line diameters!

15.11 Checking line lengths and fixings

Visually inspect the main, cascade and brake lines for cracks, kinks and chafe marks. First the A-line level, then B. etc.

- 1.) are all lines and their fixings sewn and attached correctly?
- 2.) is the coating of the lines intact?
- 3.) are all loops, knots and sewing in good condition?
- 4.) are there chafe marks?

15.12 Line length measurements:

Measuring the line lengths is part of the regular data check. The lines must be measured with a load corresponding to 5 kg in order to obtain comparable results. You can find the corresponding line lengths in the aerial sports equipment description sheet in your manual.

- 1) The measurement is carried out according to the DHV method from the (line) shackle to the cap (including the line loop on the cap).
- 2) The numbering is from the centre of the screen to the Stabilo. The measurement of the opposing wing side can also be carried out under the same conditions by a symmetry comparison
- 3) The result is noted again in the test protocol and compared with the nominal line lengths of the DHV-data sheet. The tolerance deviation should not be more than +/- 1.5 cm
- 4) If a line is defective, it must be replaced immediately. Please take the description of the lines from the line plan, order from the manufacturer and then install or have them installed accordingly by authorized professionals.

The specified values / changes are to be noted in the inspection report!

15.13 Stitch/ Sewing control of trimming and settings

Before a check flight, the canopy and lines must be checked visually when the device is laid out flat and pulled up lightly. Particular attention should be paid to the length of the control lines (brake lines) when the glider is open. A check flight may only be carried out when all concerns regarding incorrect adjustment of the control lines (brake lines) have been removed.

Please revise and study your paraglider manual

15.14 Miscellaneous

All measurement and repair work on the paraglider and rescue system must be fully documented in the inspection report. When repacking the rescue system, it is essential to pay close attention to the special packing method of the rescue system! See the rescue equipment manual for details. When replacing components or modules/ units, only original materials or original spare parts may be used! When sewing, the original sewing pattern must be observed, only use patch and thread material of the same strength and quality as the original! The verification and/ or measurement/ inspection protocol must be signed, (if an authorized dealer or service centre, stamped) including place and date!

16 IMPORTANT -> carried out inspections

- 1) Before you carry out your own tests and/ or repairs on your paraglider, we ask you to carefully read the following pages attentively. You inform yourself about the terms and conditions of a two-year examination/ check manually and carried out by yourself.
- 2) According to the new DHV regulation, the customer (glider owner) can carry out the 2-year inspection of the paraglider with his own responsibility with the help of the inspection instructions and all necessary equipment and documents. The paraglider does not have to be sent to the manufacturer for it
- 3) The 2-year inspection/ check may only be carried out personally by the paraglider owner if he/ she meets the requirements, or by the manufacturer and his authorized inspection bodies. Contact and advise with the manufacturer for any authorized test centres/ dealerships
- 4) The owner of the glider must be aware of the responsibility that he assumes with a personally and manually carried out 2-year inspection. The single-handed 2-year check is only legally effective if it is confirmed after the test with the date, printed name (in capital letters) and signature on or next to the seal of approval
- 5) Packing interval for rescue equipment: Repacking every 12 months. Permissible operating time: 10 years with an annual inspection
- 6) You should inform your insurer in good time/ advance about the legal effects of your own two-year review and check

- 7) An inspection is only valid if the inspection report is completely filled out. Also inform yourself about possible changes to the inspection instructions from the manufacturer before executing the check
- 8) Important: If the necessary expenses/ resources for the maintenance check are insufficient or cannot be made entirely (see necessary equipment and documents), the glider should be sent to the manufacturer
- 9) For paragliders, harnesses and rescue equipment that are not checked, controlled, repaired, exchanged, packed, new or repacked, flown in and/ or other maintenance work carried out other than by GRAVITY-authorized personnel, all warranty and guarantee is void!
- 10) All maintenance work must be carried out in accordance to the maintenance information in the operating instructions/ manual and the special maintenance instructions of the manufacturer and the publications of the IHB
- 11) In the event of unusual occurrences and events during the execution of the maintenance work, a technical manager from GRAVITY itself or any authorized dealer/ competence centre is to be informed, who has to decide on further procedures
- 12) When replacing components, spare-parts or units, only original materials or original spare parts are to be used!

GRAVITY airsports & more GmbH accepts no responsibility, liability and/ or guarantee for checks, inspections and repairs which are not carried out by the manufacturer or any authorized service dealer/ centre.



Stefan Berger
owner & sales